



Profile end connectors 90°



Product notes

- > Rigid 90° connection between two extrusions
- > No thread cutting required

Technical data

| Item no. | Suitable for extrusion system | Weight [g] |
|----------|-------------------------------|------------|
| GR01.121 | SLine / MLine | 90 |

Dimensions

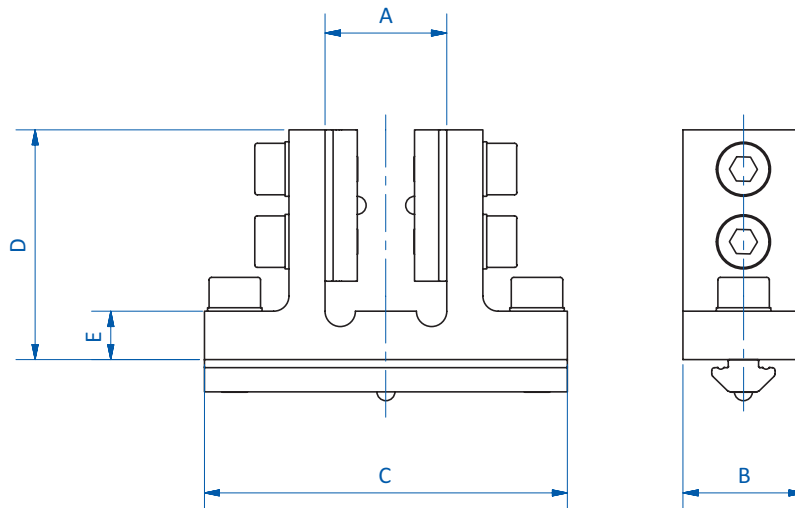

| Item no. | A [mm] | B [mm] | C [mm] | D [mm] | E [mm] |
|----------|--------|--------|--------|--------|--------|
| GR01.121 | 40 | 20 | 80 | 38 | 8 |