

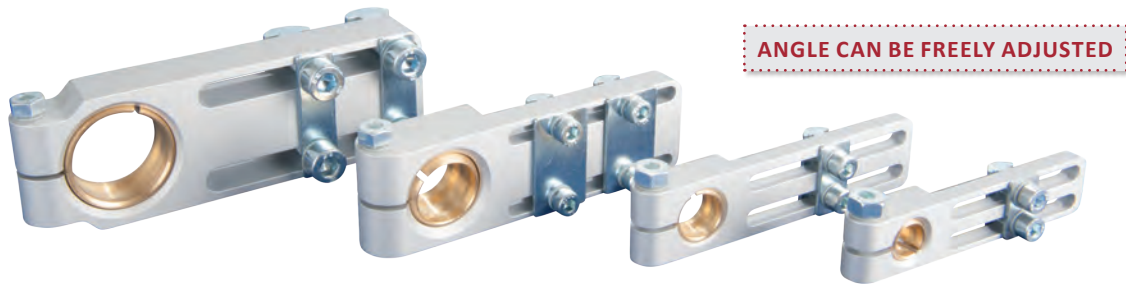

# Extrusion systems | Clamps for shafts

Long angle clamps – with ball joint

## Long angle clamps – with ball joint



### Product notes

- > Ball joint enables variable angular adjustment of gripper components
- > Allows for adjustment parallel and perpendicular to the profile frame

### Technical data

Item no.	Suitable for extrusion system	Angular adjustment [°]	Weight [g]
GR02.035	SLine / MLine	38	48

### Dimensions

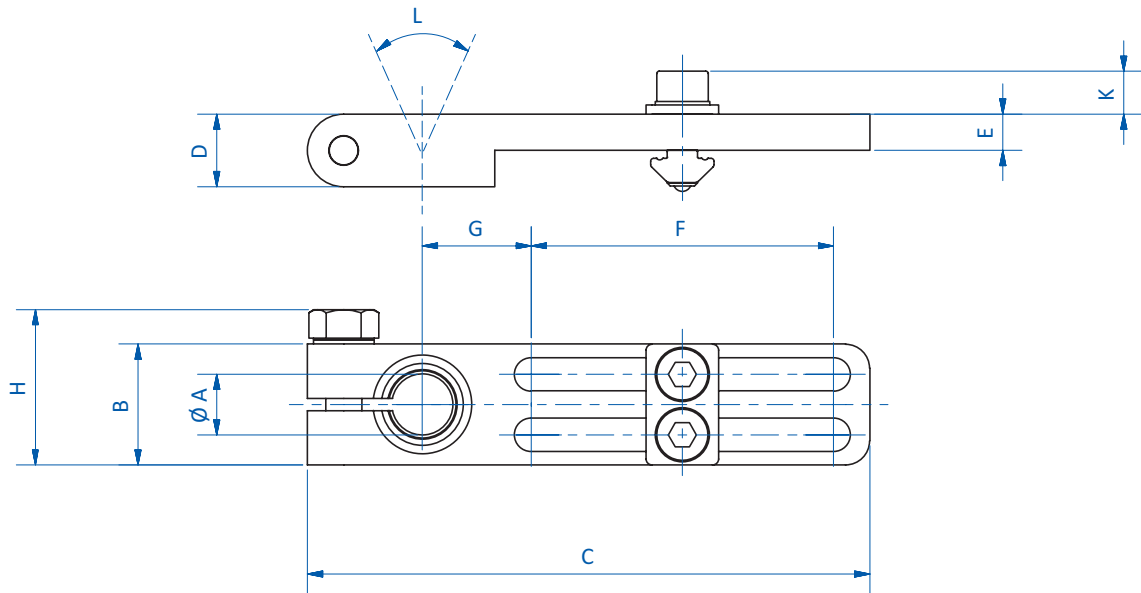

Item no.	Ø A [mm]	B [mm]	C [mm]	D [mm]	E [mm]	F [mm]	G [mm]	H [mm]	K [mm]	L [°]
GR02.035	10	20	93	12	6	50	18	25.7	7.1	38