

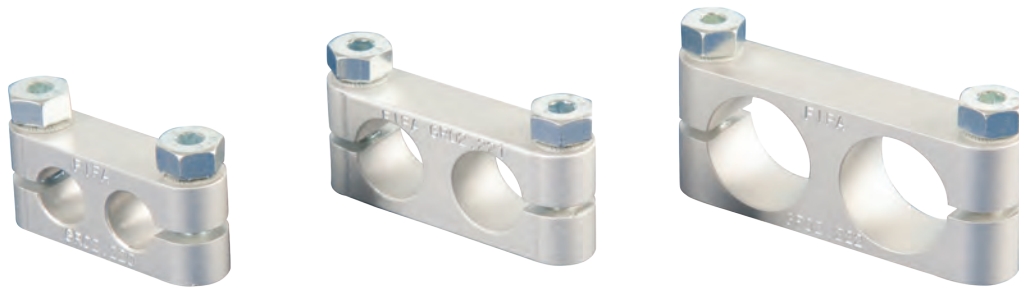

Parallel clamps



Product notes

- > Parallel connection of two clamping shafts

Technical data

Item no.	Weight [g]
GR02.220	30

Dimensions

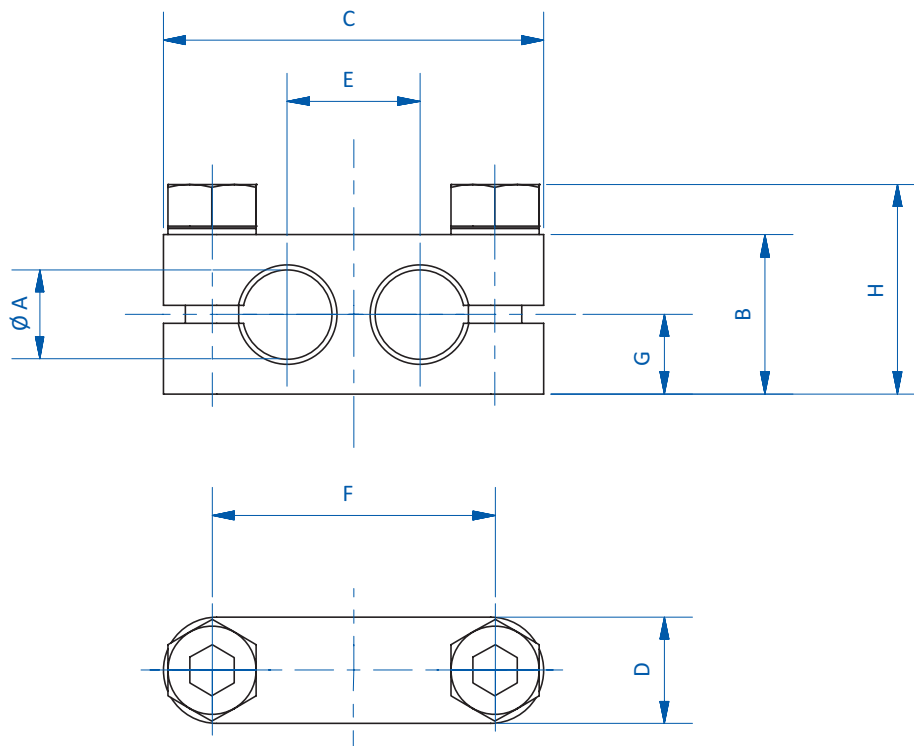

Item no.	$\varnothing A$ [mm]	B [mm]	C [mm]	D [mm]	E [mm]	F [mm]	G [mm]	H [mm]
GR02.220	10	18	43	12	15	32	9	23.7