

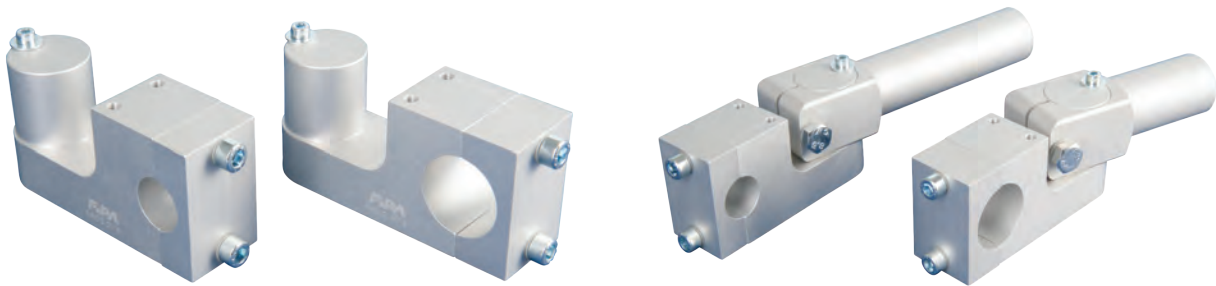

Gripper arms | Angle arms

Rotary heads for angle arms \varnothing 30 mm – heavy duty

Rotary heads for angle arms \varnothing 30 mm – heavy duty



Rotary head GR02.270 with angle arm GR02.104

Product notes

- > Rotary heads for angle arms with shaft diameter 30 mm
- > Integration of gripper elements with clamping diameter 20 mm or 30 mm
- > Secure clamping even under heavy load
- > Pivoting range 0° to ~130°, can be freely adjusted in two directions
- > Please order your combination of gripper arm and rotary head

Technical data

Item no.	Clamping \varnothing [mm]	Weight [g]	Suitable for angle arms
GR02.273	30	319	GR02.104, GR02.105, GR02.106, GR02.107



Dimensions

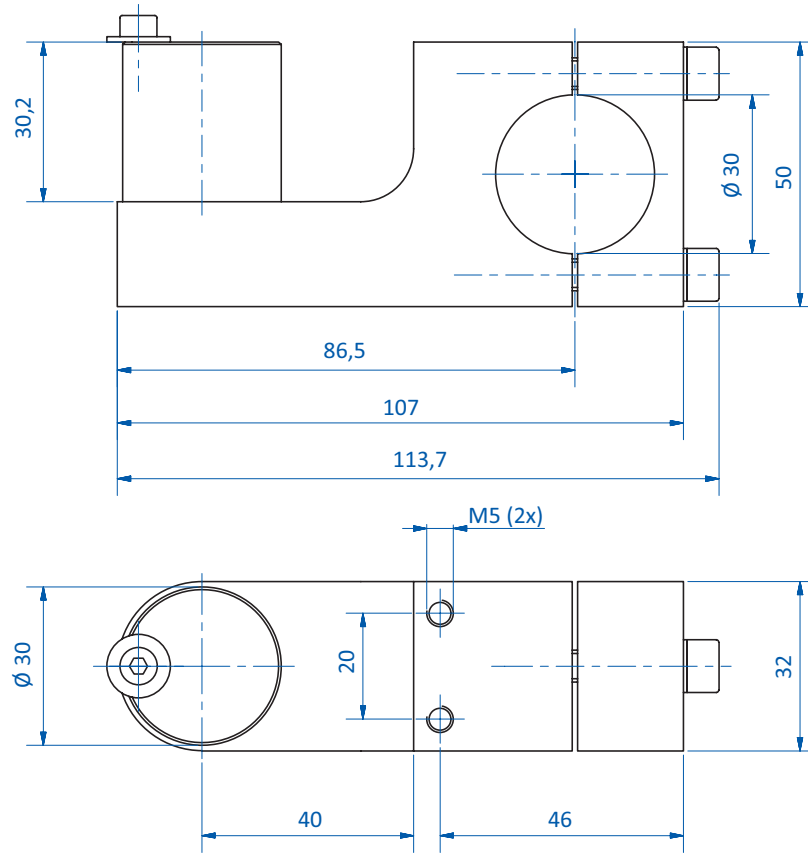

GR02.273