



Gripper arms | Suction fingers

Suction fingers for vacuum cups – rigid

Suction fingers for vacuum cups – rigid



Product notes

- > Components for mounting vacuum cups
- > Two vacuum ports

Technical data		Dimensions							
Item no.	Weight [g]	Ø A [mm]	F	G	H	□ B [mm]	E [mm]	C [mm]	L [mm]
GR03.036	64	20	G1/4	G1/8	G1/8	22	23	75.5	50



Dimensions

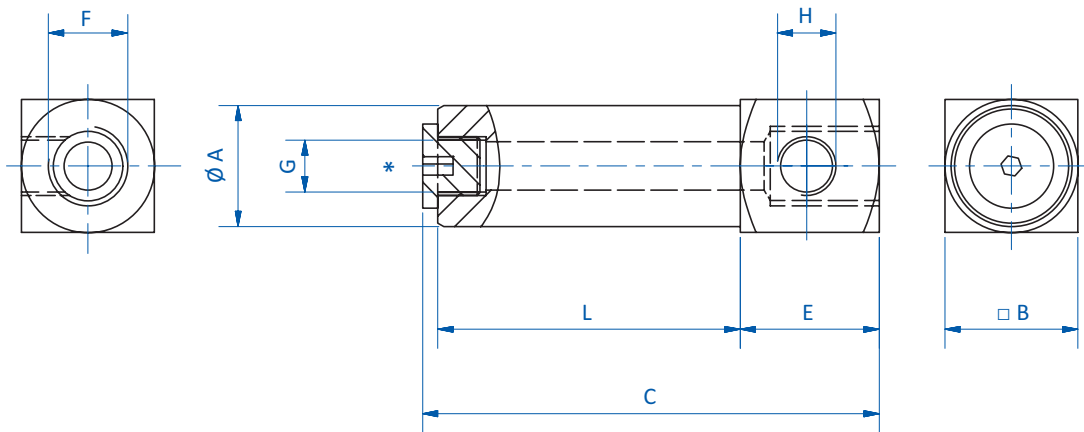

GR03.036