



Clamps with angle brackets – for direct mounting
Mounting air nippers on EOAT or special machines



Air nipper GT-NR20 assembled on extrusion SLine

Product notes

- > Mounting bracket for installation on grippers or special machines
- > Easy positioning of the air nipper thanks to 2x 90° adjustable design
- > Versatile thanks to alternative installation using slot nuts or threaded shaft holder
- > Slot nuts and mounting screws for installation on FIPA SLine and MLine extrusions included in scope of delivery

Technical data

Item no.	Weight [g]	Air nippers
GT-NR30ST2	125	GT-NR30

Dimensions

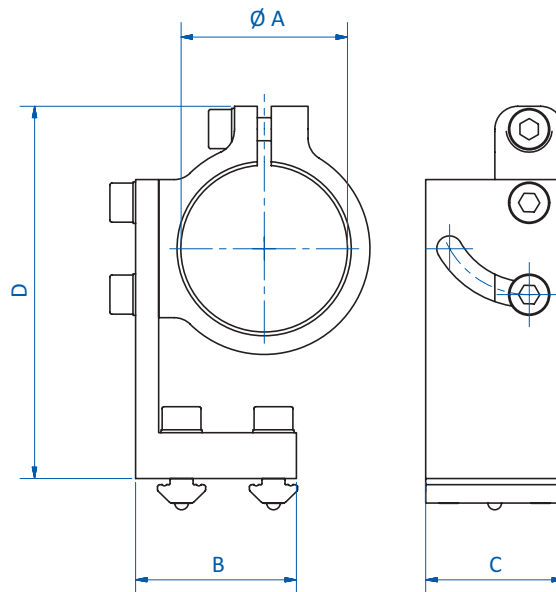

Item no.	Ø A [mm]	B [mm]	C [mm]	D [mm]
GT-NR30ST2	56	35	30	90.5