



Nipper technology | Air nippers – manual and automatic operation

Air nippers – automatic, round/square

Air nippers – automatic, round/square

AIR NIPPERS FOR PLASTIC AND METAL



Air nippers, round



Air nippers, square

Product notes

- > Air nippers for EOAT robot arms or cutting stations
- > Round body can be mounted in any angle position
- > Square body comes with bore holes on five surfaces
- > Rear air connection can be rotated 180°
- > GT-NS20H-1: air nipper with adjustable cutting opening
- > Pressure booster to increase cutting force optionally available

Technical data

Item no.	Housing	Max. cutting force [N]	Air consumption [cm ³ /stroke]	Operating pressure [bar (psi)]	Height blade [mm]	Connection [G]	Accessories
GT-NS3	Square	294	45	4 - 5 (58 - 72.5)	7	G1/8	--



Application example

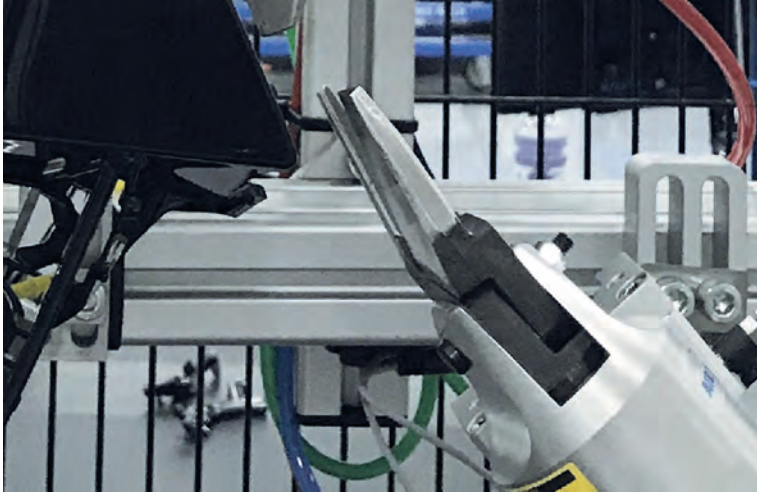

Dimensions

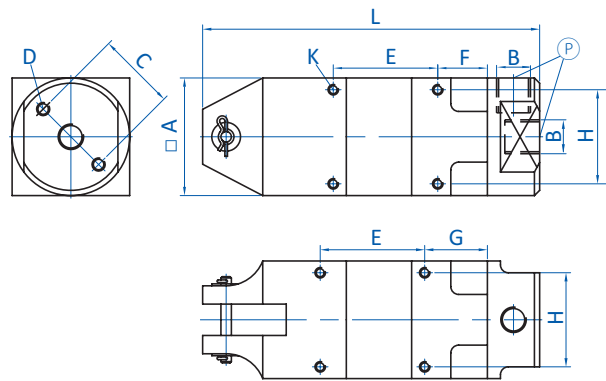

Ⓟ = Compressed air connection

Item no.	A [mm]	B	C [mm]	D	E [mm]	F [mm]	G [mm]	H [mm]	K	L [mm]
GT-NS3	23	G1/8	17	M3x8	40	19	24	19	M3x3.5	110