



rtc[®]

QUICK CONNECT TECHNOLOGY



097

rtc TYPE



Temperature Range

FPM (V) -20°C + 180°C (- 4°F + 356°F)

Working Pressure

rtc 097.08 20 bar (290 PSI)

Working Pressure
Stainless Steel

rtc 097.08 100 bar (1450 PSI)

Flow size

rtc 097.08 8 mm

Using Area

- Robotic tool changer
- On temperature regulation applications of mold and tool changer with hot or cold water, oil etc
- Injection moulding industries
- On steam line



Material of Standard Coupler

Socket body Brass

Material of Stainless Steel Coupler

Socket body Stainless Steel

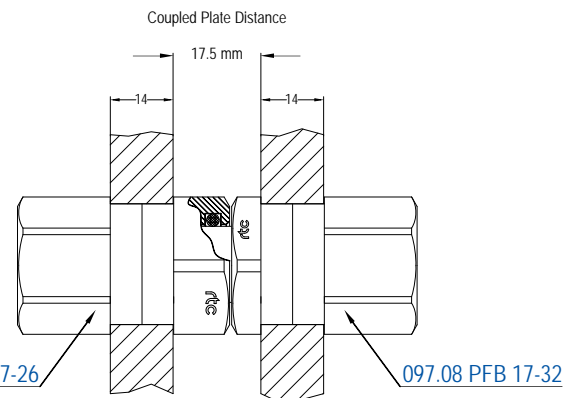
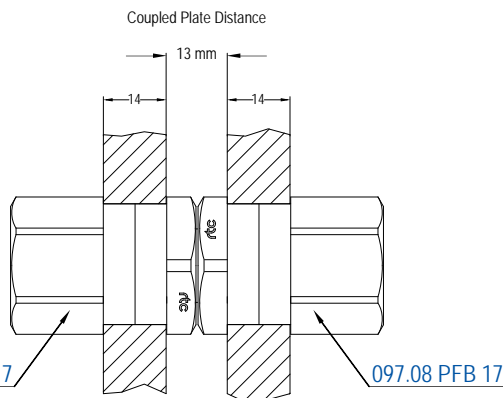

Flow Rate vs Pressure Drop Graph

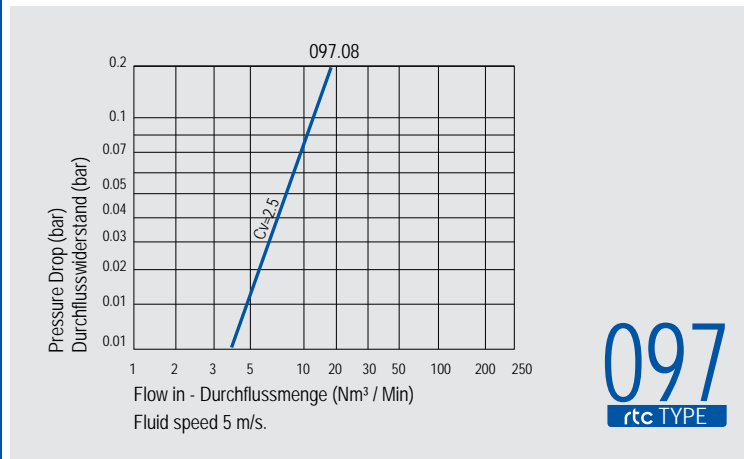

rtc TYPE 097

Male thread socket with valve / Verschlusskupplung mit Aussengewinde

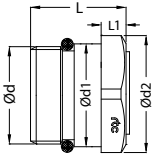

Socket / Kupplung	Size / Grosse	Order No / Bestellnr.	Ød	Ød1	Ød2	L	L1	SQR.
	8.0	097.08 SMB 2415	M24x1.5	27	29.5	22	6.5	27

rtc TYPE 097

Female thread socket with valve / Verschlusskupplung mit Innengewinde

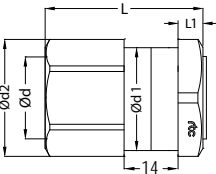

Socket / Kupplung	Size / Grosse	Order No / Bestellnr.	Ød	Ød1	Ød2	L	L1	SQR.
	8.0	097.08 SFB 17	BSP 3/8	27	29.5	40.5	6.5	27

rtc TYPE 097

90° Female thread socket with valve / Verschlusskupplung mit Innengewinde

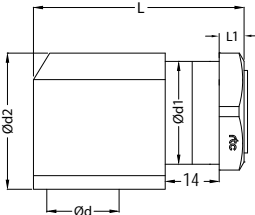

Socket / Kupplung	Size / Grosse	Order No / Bestellnr.	Ød	Ød1	Ød2	L	L1	SQR.
	8.0	097.08 SFB 17-90	BSP 3/8	27	29.5	63	6.5	27

rtc TYPE 097

Male thread plug with valve / Verschlussnippel mit Aussengewinde

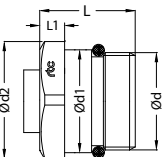

Plugs / Nippel	Size / Grosse	Order No / Bestellnr.	Ød	Ød1	Ød2	L	L1	SQR.
	8.0	097.08 PMB 2415	M24x1.5	27	29.5	22	6.5	27

rtc TYPE 097

Female thread plug with valve / Verschlussnippel mit Innengewinde

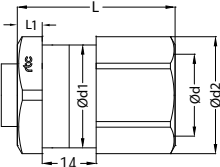

Plugs / Nippel	Size / Grosse	Order No / Bestellnr.	Ød	Ød1	Ød2	L	L1	SQR.
	8.0	097.08 PFB 17	BSP 3/8	27	29.5	46	6.5	27

rtc TYPE 097

90° Female thread plug with valve / Verschlussnippel mit Innengewinde

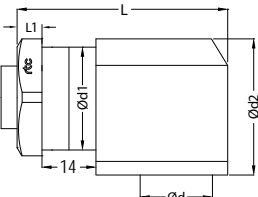

Socket / Kupplung	Size / Grosse	Order No / Bestellnr.	Ød	Ød1	Ød2	L	L1	SQR.
	8.0	097.08 PFB 17-90	BSP 3/8	27	29.5	63	6.3	27



Male thread plug with valve / Verschlussnippel mit Aussengewinde

TYPE 097

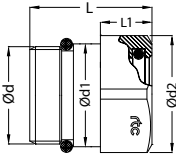

Socket / Kupplung	Size / Grosse	Order No / Bestellnr.	Ød	Ød1	Ød2	L	L1	SQR.
	8.0	097.08 SFB 2415-26	M24x1.5	27	29.5	26.5	11	27



Female thread plug with valve / Verschlussnippel mit Innengewinde

TYPE 097



Socket / Kupplung	Size / Grosse	Order No / Bestellnr.	Ød	Ød1	Ød2	L	L1	SQR.
	8.0	097.08 SFB 17-26	BSP 3/8	27	29.5	45	11	27



Plug with male thread / Nippel mit Aussengewinde

TYPE 097

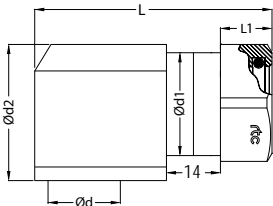

Socket / Kupplung	Size / Grosse	Order No / Bestellnr.	Ød	Ød1	Ød2	L	L1	SQR.
	8.0	097.08 SFB 17-26-90	BSP 3/8	27	29.5	67.5	11	27



Plug with male thread / Nippel mit Aussengewinde

TYPE 097

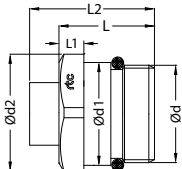

Plugs / Nippel	Size / Grosse	Order No / Bestellnr.	Ød	Ød1	Ød2	L	L1	L2	SQR.
	8.0	097.08 PMB 2415-32	M24x1.5	27	29.5	22	6.5	32	27



Plug with male thread / Nippel mit Aussengewinde

TYPE 097

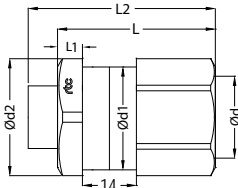

Plugs / Nippel	Size / Grosse	Order No / Bestellnr.	Ød	Ød1	Ød2	L	L1	L2	SQR.
	8.0	097.08 PFB 17-32	BSP 3/8	27	29.5	46	6.5	50.5	27



Plug with male thread / Nippel mit Aussengewinde

TYPE 097

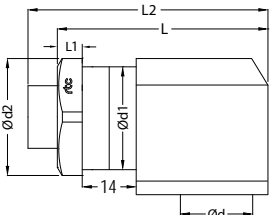

Socket / Kupplung	Size / Grosse	Order No / Bestellnr.	Ød	Ød1	Ød2	L	L1	L2	SQR.
	8.0	097.08 PFB 17-32-90	BSP 3/8	27	29.5	63	6.5	73	27