



"Inline" pressure regulators with pressure gauge



Product notes

- > Defined reduction in operating pressure for ejectors, limitation of holding force of grippers
- > Easy installation thanks to vertical and horizontal cross holes
- > Pressure adjustment by means of knurled screw, pressure monitoring by means of gauges (readout in MPa)
- > Integrated overpressure protection
- > Only suitable for compressed air

Technical data

Item no.	Operating pressure [bar (psi)]	Regulating range [bar (psi)]	Accuracy (\pm) [%]	Operating temperature [$^{\circ}$ C ($^{\circ}$ F)]	Weight [g]
32.585	0 - 9 (0 - 130.5)	1 - 8 (14.5 - 116)	5	0 - 60 (32 - 140)	73

Dimensions

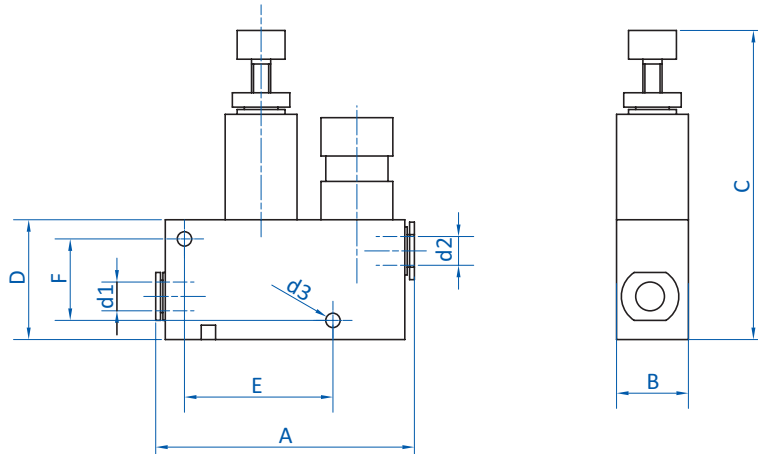

Item no.	d1 [mm]	d2 [mm]	d3 [mm]	A [mm]	B [mm]	C [mm]	D [mm]	E [mm]	F [mm]
32.585	8	6	3.2	69	19	67.5	29	39	21