



Multi-chamber ejectors

High suction power for fast vacuum build up with porous workpieces



Application example: Multi-chamber ejector with vacuum gauge 91.001 (mounting on front or rear side)



Application example: Multi-chamber ejector 65.340-LSE with air saving function

Product notes

- > High vacuum level at low feed pressures, and thus particularly efficient use of compressed air as well as suitability for fluctuating air pressure levels
- > Handling of porous products, or for high leakages
- > High suction power for short evacuation times in the lower vacuum range
- > Noise-optimized operation due to open silencer
- > Industry examples: packaging and printing

Air saving function (Index LSE)

- > Saving compressed air during handling of dense workpieces
- > Examples of use:
Automatic switching off of vacuum generation during Pick & Place applications of dense workpieces if e.g. downstream processes are delayed. Saving compressed air when using the multi-chamber ejectors for feeding vacuum tanks.

Notes

Construction / operation (Index -LSE):

- > Combination of pneumatic control valve with spring return and normally closed (NC) pneumatic vacuum switch
- > Setting target vacuum values by means of setting screw
- > Compressed air is conveyed through the valve to the compressed-air inlet of the injector; there is a partial airflow at input 1 of the vacuum switch
- > When set target vacuum is reached, vacuum switch opens, compressed air from input 1 is conducted to the control valve via output 2 and closes it - the vacuum generation is stopped
- > If the vacuum level has reached the hysteresis value (see table), the vacuum switch closes again and the spring opens the control valve - vacuum generation is activated again
- > Please note: The air saving function does not work with porous products, or in the case of high leakage

Ordering notes

- > Seals optionally available in NBR as standard
- > Optionally available in EPDM or Viton upon request
- > Included in scope of delivery: Two mounting brackets and G1/4"-male – Ø 10 mm quick fitting for compressed air connection

Technical data

Item no.
Optimal operating pressure [bar (psi)]
Max. operating pressure [bar (psi)]
Final vacuum at 3.4 bar (49.3 psi) [%]
Final vacuum at 6 bar (87 psi) [%]
Suction power at 3.4 bar (49.3 psi) [NI/min]
Suction power at 6 bar (87 psi) [NI/min]
Air consumption at 3.4 bar (49.3 psi) [NI/min]
Air consumption at 6 bar (87 psi) [NI/min]
Evacuation time 1 liter from 0 to 70 % at 3.4 bar (49.3 psi) [s]

65.380
3.4 (49.3)
7 (101.5)
92
89
1,150
1,400
545
780
0.2



Technical data

Item no.
Evacuation time 0 to 70 % at 6 bar (87 psi) [s]
Vacuum switch hysteresis at LSE [mbar (inHg)]
Noise level with silencer [dB]
Usage temperature [°C (°F)]
Weight incl. silencer [g]
Suitable accessories

65.380
0.19
120 (3.5)
60 - 65
-20 - 80 (-4 - 176)
1,160
Vacuum gauge: 91.001 Vacuum switch: GS02.001 Double nipple: 270.138 Double nipple: 270.148 Silencer: 72.033

When ordering please specify

Air saving function

Item no.	Design
65.340	without air saving function
65.340 -LSE	with air saving function

Already built in for 65.340-LSE to 65.390-LSE.

If the LSE is integrated in already delivered structurally identical ejectors without an air saving function, a non-return valve, item no. 32.662, is necessary at the compressed air input. For conversion of existing ejectors please consult the FIPA technical sales department.

For 65-380-LSE and 65.390-LSE:

It is recommended particular to consult FIPA technical sales department as to whether an air saving function is useful in the application.

Wiring diagram air saving function LSE

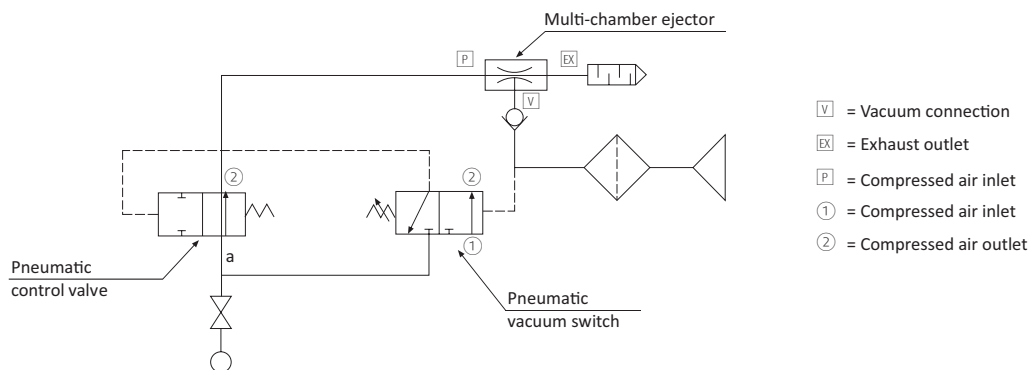



Recommended inner diameter [mm] for tubing up to length of 2 meter

Item no.	Air supply	Vacuum	Exhaust
65.380	65.380-LSE	> 10	> 25
			> 32

Dimensions

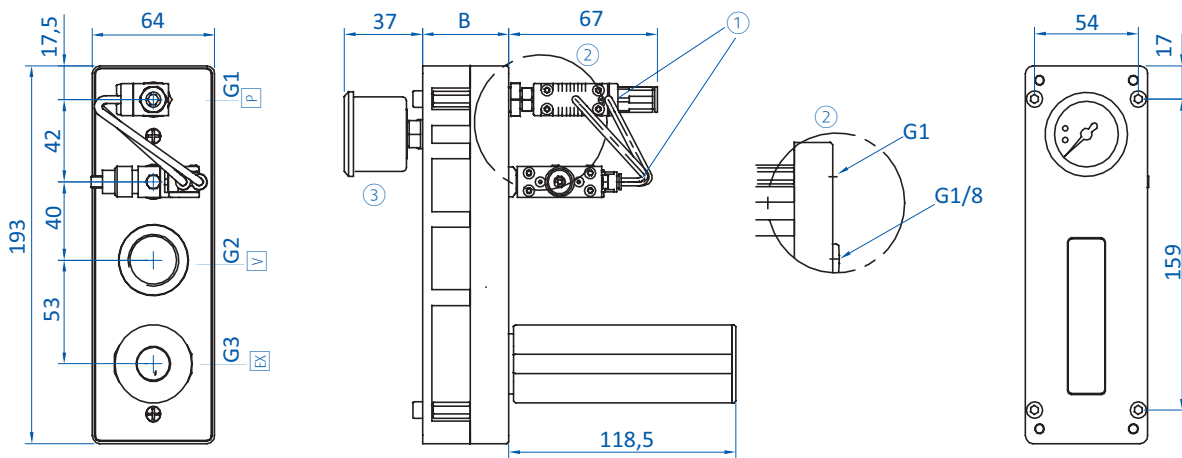

① = Air saving function (optional) ② = Connection vacuum gauge and/or vacuum switch ③ = Vacuum gauge (optional)
 P = Compressed air connection V = Vacuum connection X = Exhaust outlet

Item no.
G1
G2
G3
B [mm]

65.380
G1/4
G1
G1
85