

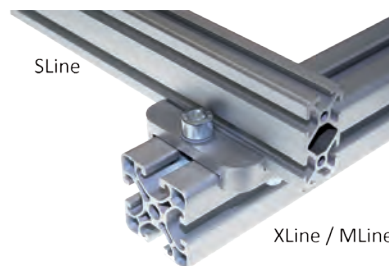

Cross joint connectors



Product notes

> Elements for 90° connection of SLine with MLine or XLine extrusions

Technical data

Item no.	Suitable for extrusion system	Weight [g]
GR01.024	SLine / XLine	119

Dimensions

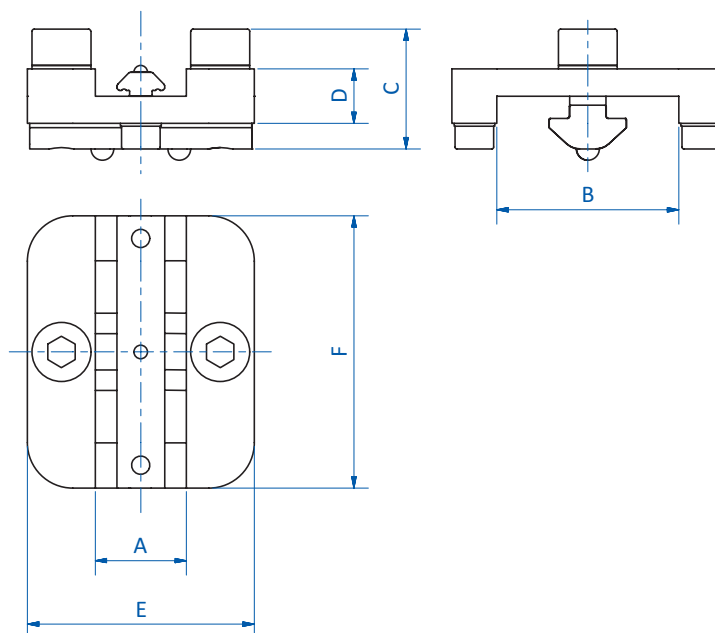

Item no.	A [mm]	B [mm]	C [mm]	D [mm]	E [mm]	F [mm]
GR01.024	20	40	27	12	50	60