



Cross clamps



Product notes

- > Elements for 90° clamping of gripper components
- > Clamp allows transition from profile systems to a tubular system

Technical data

Item no.	Suitable for extrusion system	Weight [g]
GR02.022	SLine / MLine	43

Dimensions

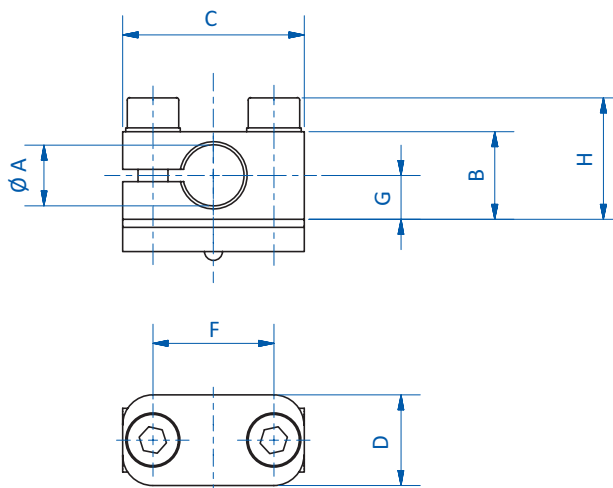

Item no.	Ø A [mm]	B [mm]	C [mm]	D [mm]	F [mm]	G [mm]	H [mm]
GR02.022	20	24.5	40	15	30	12.3	30.1