

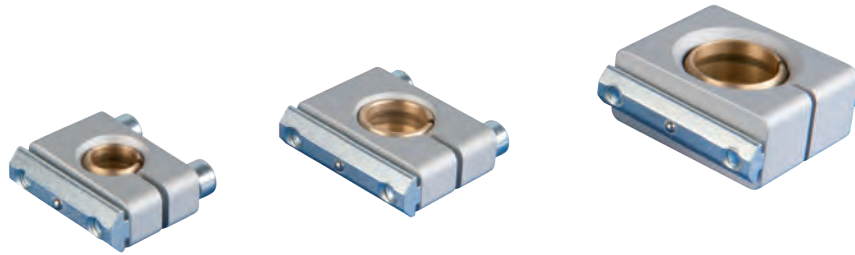

Cross clamps – with ball joint



Product notes

- > Elements for clamping of gripper components
- > Ball joint enables variable angular adjustment of gripper components up to max. 19°

Technical data

Item no.	Suitable for extrusion system	Angular adjustment [°]	Weight [g]
GR02.023-KG	SLine / MLine	17	49

Dimensions

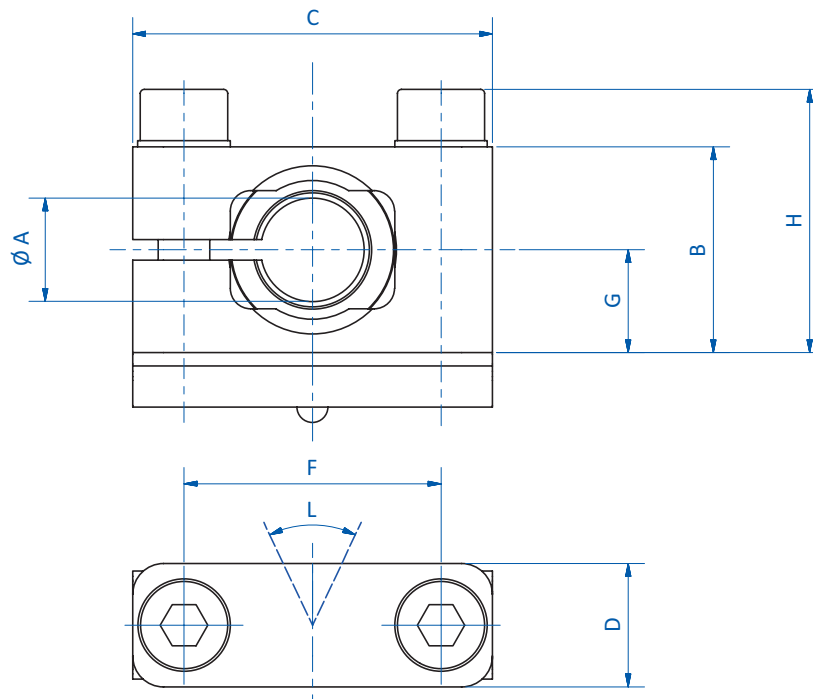

Item no.	Ø A [mm]	B [mm]	C [mm]	D [mm]	F [mm]	G [mm]	H [mm]	L [°]
GR02.023-KG	14	25	40	12	30	12.5	30.6	17