



Cross clamps 90°



Product notes

- > Perpendicular clamping of tubular components
- > Versatile 90° connection of two clamping shafts of the same size

Technical data

Item no.	Weight [g]
GR02.211	33

Dimensions

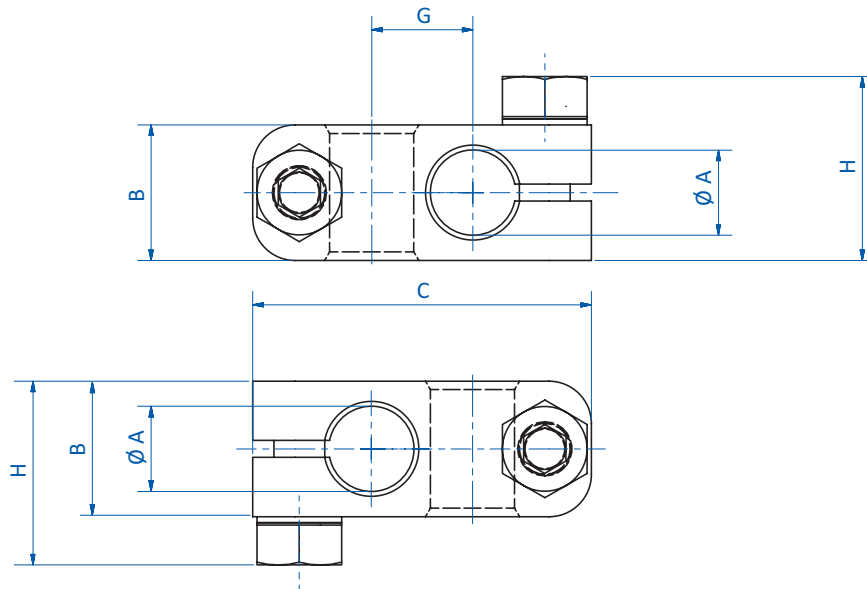

Item no.	Ø A [mm]	B [mm]	C [mm]	G [mm]	H [mm]
GR02.211	14	18	48	16	23.7