

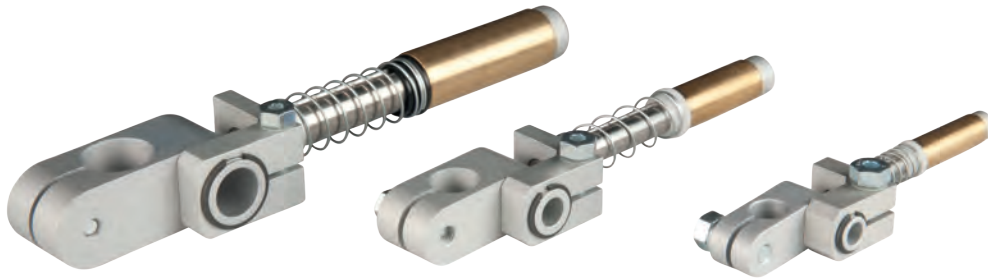

Gripper arms | Angle arms

Elbow arms – spring compensated and non-rotating

Elbow arms – spring compensated and non-rotating



Product notes

- > Components for mounting grippers, gripper fingers or gripper arms
- > Spring compensates for variation in ejection stroke
- > Angle adjustment +/- 130°
- > Smooth motion due to lubrication-free polymer bearing

Technical data

Item no.	Stroke [mm]	Weight [g]
GR03.164	20	288

Dimensions

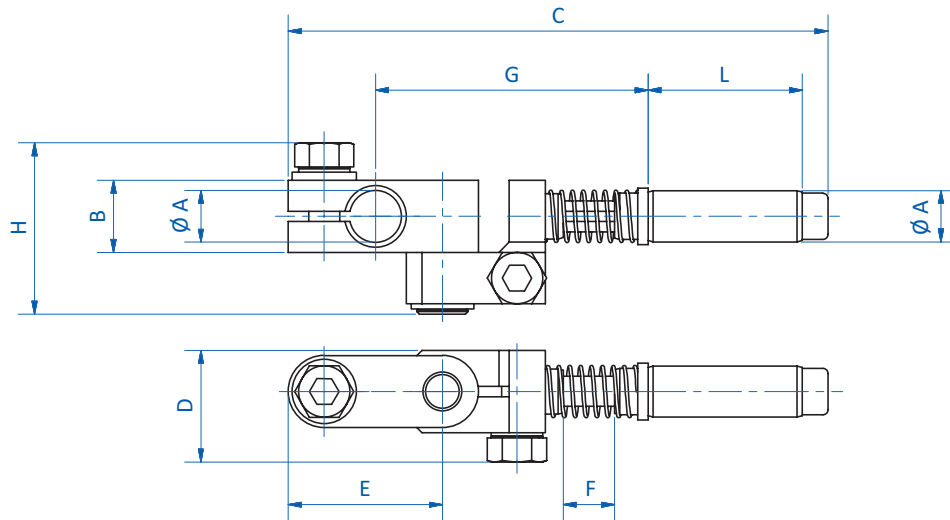

Item no.	Ø A [mm]	B [mm]	C [mm]	D [mm]	E [mm]	F [mm]	G [mm]	H [mm]	L [mm]
GR03.164	20	25	179.5	30.7	52	20	87.5	42.7	55