



# Nipper technology | Air nippers – manual and automatic operation

## Air nippers for manual operation

### Air nippers for manual operation



AIR NIPPERS FOR PLASTIC AND METAL

### Product notes

- > Manually operated air nippers with safety lever
- > Round shaped body with knurling for safe grip
- > GT-N20, N30 and N50 come with stopcock to lock compressed air supply
- > Pressure booster to increase cutting force optionally available

### Technical data

Item no.	Max. cutting force [N]	Air consumption [cm <sup>3</sup> /stroke]	Operating pressure [bar (psi)]	Height blade [mm]	Connection [G]	Weight [g]	Pressure amplifier	Dimensions	
								Ø A [mm]	L [mm]
GT-N3	294	45	4 - 5 (58 - 72.5)	7	G1/4	100	--	23	112

### Dimensions

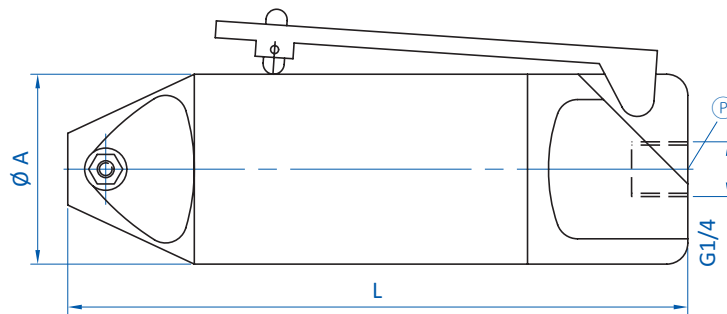

Ⓟ = Compressed air connection