



Nipper technology | Air nippers – manual and automatic operation

Air nippers for manual operation

Air nippers for manual operation



AIR NIPPERS FOR PLASTIC AND METAL

Product notes

- > Manually operated air nippers with safety lever
- > Round shaped body with knurling for safe grip
- > GT-N20, N30 and N50 come with stopcock to lock compressed air supply
- > Pressure booster to increase cutting force optionally available

Technical data

Item no.	Max. cutting force [N]	Air consumption [cm ³ /stroke]	Operating pressure [bar (psi)]	Height blade [mm]	Connection [G]	Weight [g]	Pressure amplifier	Dimensions	
								Ø A [mm]	L [mm]
GT-N30	2,744	584	5 - 6 (72.5 - 87)	17	G1/4	685	P-30	56	193

Dimensions

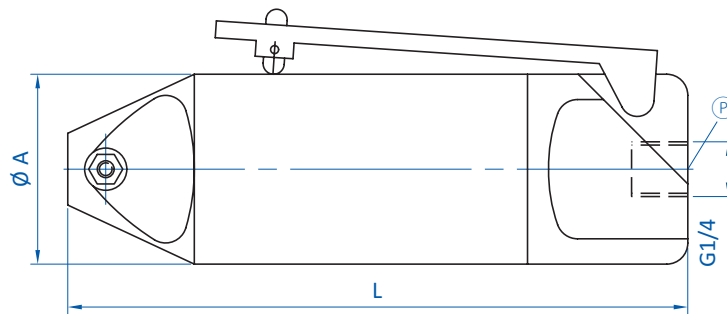

Ⓟ = Compressed air connection