



SERIE M101 RTC



RTC COUPLINGS

WATER MULTICOUPLING MULTICOUPLING SYSTEMS

MULTICOUPLING EQUIVALENTE

6
6
9
9
10
10
12
12
16
16

LADO PRENSA - MANGUERA

MM 106.06 HGB 08	M 101.06-06 SHB 08
MM 106.06 HGB 10	M 101.06-06 SHB 10
MM 109.06 HGB 10	M 101.09-06 SHB 10
MM 109.06 HGB 12	M 101.09-06 SHB 12
	M 101.10-06 SHB 10
	M 101.10-06 SHB 12
MM 112.06 HGB 12	M 101.12-06 SHB 12
MM 112.06 HGB 16	M 101.12-06 SHB 16
MM 116.06 HGB 16	M 101.16-06 SHB 16
MM 116.06 HGB 19	M 101.16-06 SHB 19

info@hidrafluid.es

Telf: (+34) 976 24 32 10

www.rtc-tec.com

QUICK CONNECT TECHNOLOGY



SERIE M101 RTC



RTC COUPLINGS

WATER MULTICOUPLING MULTICOUPLING SYSTEMS

MULTICOUPLING EQUIVALENTE

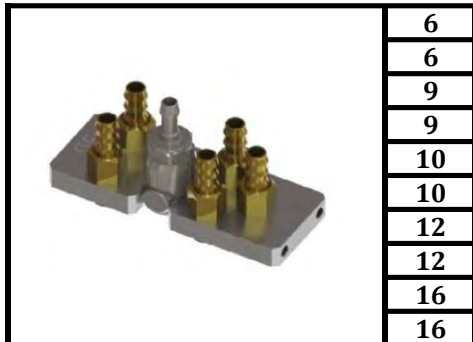

LADO PRENSA - PUSH LOK

MM 106.06 FGB 08	M 101.06-06 SPB 08
MM 106.06 FGB 10	M 101.06-06 SPB 10
MM 109.06 FGB 10	M 101.09-06 SPB 10
MM 109.06 FGB 13	M 101.09-06 SPB 13
	M 101.10-06 SPB 10
	M 101.10-06 SPB 13
MM 112.06 FGB 13	M 101.12-06 SPB 13
MM 112.06 FGB 16	M 101.12-06 SPB 16
MM 116.06 FGB 16	M 101.16-06 SPB 16
MM 116.06 FGB 19	M 101.16-06 SPB 19

info@hidrafluid.es

Telf: (+34) 976 24 32 10

www.rtc-tec.com

QUICK CONNECT TECHNOLOGY



SERIE M101 RTC



RTC COUPLINGS

WATER MULTICOUPLING MULTICOUPLING SYSTEMS

MULTICOUPLING EQUIVALENTE

6
6
9
9
10
10
12
12
16
16

LADO PRENSA - ROSCA

MM 106.06 DGB 13	M 101.06-06 SFB 13
MM 106.06 NGB 13	M 101.06-06 SNB 13
MM 109.06 DGB 17	M 101.09-06 SFB 17
MM 109.06 NGB 17	M 101.09-06 SNB 17
	M 101.10-06 SFB 17
	M 101.10-06 SNB 17
MM 112.06 DGB 21	M 101.12-06 SFB 21
MM 112.06 NGB 21	M 101.12-06 SNB 21
MM 116.06 DGB 26	M 101.16-10 SFB 26
MM 116.06 NGB 26	M 101.16-10 SNB 26

info@hidrafluid.es

Telf: (+34) 976 24 32 10

www.rtc-tec.com

QUICK CONNECT TECHNOLOGY



SERIE M101 RTC



RTC COUPLINGS

WATER MULTICOUPLING MULTICOUPLING SYSTEMS

MULTICOUPLING EQUIVALENTE

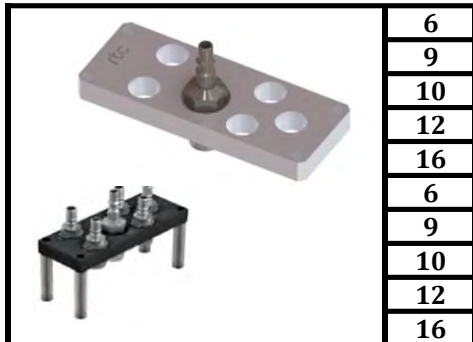

LADO MOLDE

MK 106.06	K 101.06-06
MK 109.06	K 101.09-06
	K 101.10-06
MK 112.06	K 101.12-06
MK 116.06	K 101.16-06
	K 101.06-06 PMB 13
	K 101.09-06 PMB 17
	K 101.10-06 PMB 17
	K 101.12-06 PMB 21
	K 101.16-06 PMB 26

info@hidrafluid.es

Telf: (+34) 976 24 32 10

www.rtc-tec.com

QUICK CONNECT TECHNOLOGY



SERIE M101 RTC



RTC COUPLINGS

WATER MULTICOUPLING MULTICOUPLING SYSTEMS

MULTICOUPLING EQUIVALENTE

	9
	9
	10
	10
	9
	9
	10
	10

LADO PRENSA - MANGUERA + PUSH LOK

MM 109.08 HGB 10	M 101.09-08 SHB 10
MM 109.08 HGB 12	M 101.09-08 SHB 12
	M 101.10-08 SHB 10
	M 101.10-08 SHB 12
MM 109.08 FGB 10	M 101.09-08 SPB 10
MM 109.08 FGB 13	M 101.09-08 SPB 13
	M 101.10-08 SPB 10
	M 101.10-08 SPB 13

info@hidrafluid.es

Telf: (+34) 976 24 32 10

www.rtc-tec.com

QUICK CONNECT TECHNOLOGY



SERIE M101 RTC



RTC COUPLINGS

WATER MULTICOUPLING
MULTICOUPLING SYSTEMS

MULTICOUPLING EQUIVALENTE

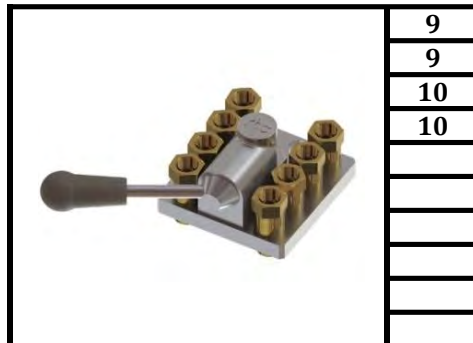

LADO PRENSA - ROSCADO

MM 109.08 DGB 17	M 101.09-08 SFB 17
MM 109.08 NGB 17	M 101.09-08 SNB 17
	M 101.10-08 SFB 17
	M 101.10-08 SNB 17

info@hidrafluid.es
Telf: (+34) 976 24 32 10

www.rtc-tec.com
QUICK CONNECT TECHNOLOGY



SERIE M101 RTC



RTC COUPLINGS

WATER MULTICOUPLING
MULTICOUPLING SYSTEMS

MULTICOUPLING EQUIVALENTE

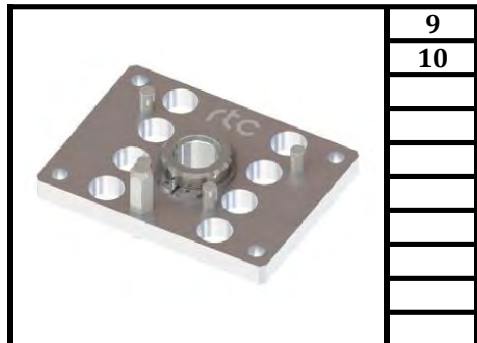

LADO MOLDE

MK 109.08	K 101.09-08
	K 101.10-08

info@hidrafluid.es
Telf: (+34) 976 24 32 10

www.rtc-tec.com
QUICK CONNECT TECHNOLOGY



SERIE M101 RTC



RTC COUPLINGS

WATER MULTICOUPLING MULTICOUPLING SYSTEMS

MULTICOUPLING EQUIVALENTE

	9
	9
	10
	10
	12
	12
	16
	16

LADO PRENSA - MANGUERA

MM 109.10 HGB 10	M 101.09-10 SHB 10
MM 109.10 HGB 12	M 101.09-10 SHB 12
	M 101.10-10 SHB 10
	M 101.10-10 SHB 12
MM 112.10 HGB 12	M 101.12-10 SHB 12
MM 112.10 HGB 16	M 101.12-10 SHB 16
MM 116.10 HGB 16	M 101.16-10 SHB 16
MM 116.10 HGB 19	M 101.16-10 SHB 19

info@hidrafluid.es

Telf: (+34) 976 24 32 10

www.rtc-tec.com

QUICK CONNECT TECHNOLOGY



SERIE M101 RTC



RTC COUPLINGS

WATER MULTICOUPLING MULTICOUPLING SYSTEMS

MULTICOUPLING EQUIVALENTE

	9
	9
	10
	10
	12
	12
	16
	16

LADO PRENSA - PUSH LOK

MM 109.10 FGB 10	M 101.09-10 SPB 10
MM 109.10 FGB 13	M 101.09-10 SPB 13
	M 101.10-10 SPB 10
	M 101.10-10 SPB 13
MM 112.10 FGB 13	M 101.12-10 SPB 13
MM 112.10 FGB 16	M 101.12-10 SPB 16
MM 116.10 FGB 16	M 101.16-10 SPB 16
MM 116.10 FGB 19	M 101.16-10 SPB 19

info@hidrafluid.es

Telf: (+34) 976 24 32 10

www.rtc-tec.com

QUICK CONNECT TECHNOLOGY



SERIE M101 RTC



RTC COUPLINGS

WATER MULTICOUPLING MULTICOUPLING SYSTEMS

MULTICOUPLING EQUIVALENTE

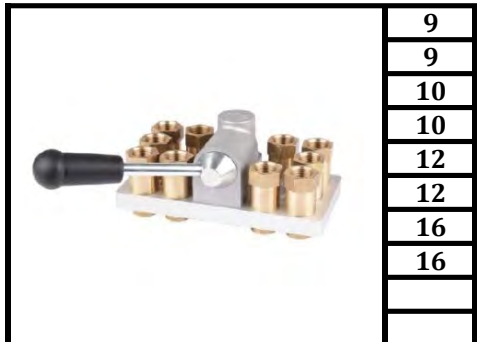

LADO PRENSA - ROSCA

MM 109.10 DGB 17	M 101.09-10 SFB 17
MM 109.10 NGB 17	M 101.09-10 SNB 17
	M 101.10-10 SFB 17
	M 101.10-10 SNB 17
MM 112.10 DGB 21	M 101.12-10 SFB 21
MM 112.10 NGB 21	M 101.12-10 SNB 21
MM 116.10 DGB 26	M 101.16-10 SFB 26
MM 116.10 NGB 26	M 101.16-10 SNB 26

info@hidrafluid.es

Telf: (+34) 976 24 32 10

www.rtc-tec.com

QUICK CONNECT TECHNOLOGY



SERIE M101 RTC



RTC COUPLINGS

WATER MULTICOUPLING
MULTICOUPLING SYSTEMS

MULTICOUPLING EQUIVALENTE

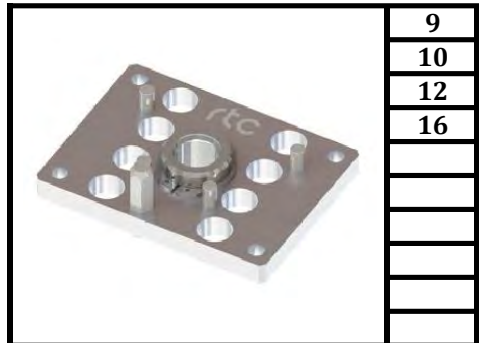

LADO MOLDE

MK 109.10	K 101.09-10
	K 101.10-10
MK 112.10	K 101.12-10
MK 116.10	K 101.16-10

info@hidrafluid.es
Telf: (+34) 976 24 32 10

www.rtc-tec.com
QUICK CONNECT TECHNOLOGY



SERIE M101 RTC



RTC COUPLINGS

WATER MULTICOUPLING
MULTICOUPLING SYSTEMS

MULTICOUPLING EQUIVALENTE

	9
	9
	10
	10
	12
	12
	16
	16

LADO PRENSA - MANGUERA

	K 101.09-10 PMB 17
	K 101.09-10 PMF 17
	K 101.10-10 PMB 17
	K 101.10-10 PMF 17
	K 101.12-10 PMB 21
	K 101.12-10 PMF 21
	K 101.16-10 PMB 26
	K 101.16-10 PMF 26

info@hidrafluid.es

Telf: (+34) 976 24 32 10

www.rtc-tec.com

QUICK CONNECT TECHNOLOGY



SERIE M101 RTC



RTC COUPLINGS

WATER MULTICOUPLING MULTICOUPLING SYSTEMS

MULTICOUPLING EQUIVALENTE



6
6
9
9
10
10
12
12
16
16

LADO PRENSA - MANGUERA

MM 106.12 HGB 08	M 101.06-12 SHB 08
MM 106.12 HGB 10	M 101.06-12 SHB 10
MM 109.12 HGB 10	M 101.09-12 SHB 10
MM 109.12 HGB 12	M 101.09-12 SHB 12
	M 101.10-12 SHB 10
	M 101.10-12 SHB 12
MM 112.12 HGB 12	M 101.12-12 SHB 12
MM 112.12 HGB 16	M 101.12-12 SHB 16
MM 116.12 HGB 16	M 101.16-12 SHB 16
MM 116.12 HGB 19	M 101.16-12 SHB 19

info@hidrafluid.es

Telf: (+34) 976 24 32 10

www.rtc-tec.com

QUICK CONNECT TECHNOLOGY



SERIE M101 RTC



RTC COUPLINGS

WATER MULTICOUPLING MULTICOUPLING SYSTEMS

MULTICOUPLING EQUIVALENTE

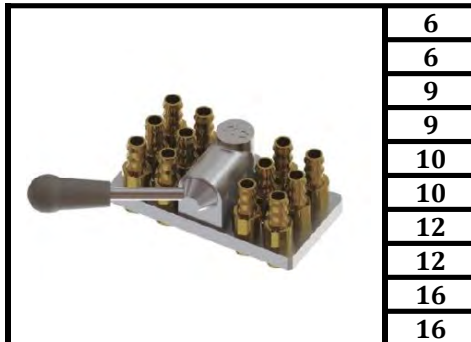

LADO PRENSA - PUSH LOK

MM 106.12 FGB 08	M 101.06-12 SPB 08
MM 106.12 FGB 10	M 101.06-12 SPB 10
MM 109.12 FGB 10	M 101.09-12 SPB 10
MM 109.12 FGB 13	M 101.09-12 SPB 13
	M 101.10-12 SPB 10
	M 101.10-12 SPB 13
MM 112.12 FGB 13	M 101.12-12 SPB 13
MM 112.12 FGB 16	M 101.12-12 SPB 16
MM 116.12 FGB 16	M 101.16-12 SPB 16
MM 116.12 FGB 19	M 101.16-12 SPB 19

info@hidrafluid.es

Telf: (+34) 976 24 32 10

www.rtc-tec.com

QUICK CONNECT TECHNOLOGY



SERIE M101 RTC



RTC COUPLINGS

WATER MULTICOUPLING MULTICOUPLING SYSTEMS

MULTICOUPLING EQUIVALENTE

6
6
9
9
10
10
12
12
16
16

LADO PRENSA - ROSCA

MM 106.12 DGB 13	M 101.06-12 SFB 13
MM 106.12 NGB 13	M 101.06-12 SNB 13
MM 109.12 DGB 17	M 101.09-12 SFB 17
MM 109.12 NGB 17	M 101.09-12 SNB 17
	M 101.10-12 SFB 17
	M 101.10-12 SNB 17
MM 112.12 DGB 21	M 101.12-12 SFB 21
MM 112.12 NGB 21	M 101.12-12 SNB 21
MM 116.12 DGB 26	M 101.16-10 SFB 26
MM 116.12 NGB 26	M 101.16-10 SNB 26

info@hidrafluid.es

Telf: (+34) 976 24 32 10

www.rtc-tec.com

QUICK CONNECT TECHNOLOGY



SERIE M101 RTC



RTC COUPLINGS

WATER MULTICOUPLING MULTICOUPLING SYSTEMS

MULTICOUPLING EQUIVALENTE

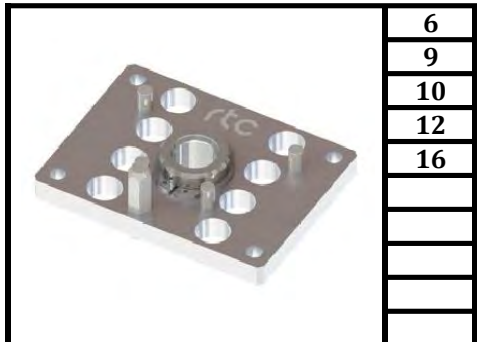

LADO MOLDE

MK 106.12	K 101.06-12
MK 109.12	K 101.09-12
	K 101.10-12
MK 112.12	K 101.12-12
MK 116.12	K 101.16-12

info@hidrafluid.es

Telf: (+34) 976 24 32 10

www.rtc-tec.com

QUICK CONNECT TECHNOLOGY



SERIE M101 RTC



RTC COUPLINGS

WATER MULTICOUPLING MULTICOUPLING SYSTEMS

MULTICOUPLING EQUIVALENTE

	9
	9
	10
	10
	9
	9
	10
	10

LADO PRENSA - MANGUERA + PUSH LOK

MM 109.16 HGB 10	M 101.09-16 SHB 10
MM 109.16 HGB 12	M 101.09-16 SHB 12
	M 101.10-16 SHB 10
	M 101.10-16 SHB 12
MM 109.16 FGB 10	M 101.09-16 SPB 10
MM 109.16 FGB 13	M 101.09-16 SPB 13
	M 101.10-16 SPB 10
	M 101.10-16 SPB 13

info@hidrafluid.es

Telf: (+34) 976 24 32 10

www.rtc-tec.com

QUICK CONNECT TECHNOLOGY



SERIE M101 RTC



RTC COUPLINGS

WATER MULTICOUPLING
MULTICOUPLING SYSTEMS

MULTICOUPLING EQUIVALENTE

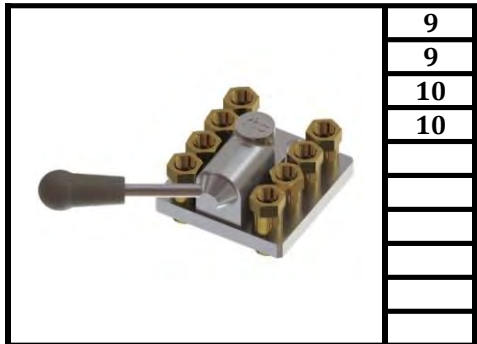

LADO PRENSA - ROSCADO

MM 109.16 DGB 17	M 101.09-16 SFB 17
MM 109.16 NGB 17	M 101.09-16 SNB 17
	M 101.10-16 SFB 17
	M 101.10-16 SNB 17

info@hidrafluid.es
Telf: (+34) 976 24 32 10

www.rtc-tec.com
QUICK CONNECT TECHNOLOGY



SERIE M101 RTC



RTC COUPLINGS

**WATER MULTICOUPLING
MULTICOUPLING SYSTEMS**

MULTICOUPLING EQUIVALENTE

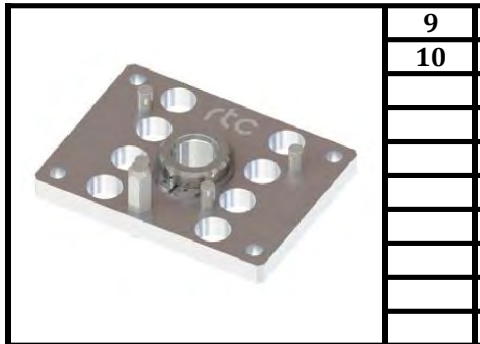

LADO MOLDE

MK 109.16	K 101.09-16
	K 101.10-16

info@hidrafluid.es
Telf: (+34) 976 24 32 10

www.rtc-tec.com
QUICK CONNECT TECHNOLOGY



SERIE M101 RTC



RTC COUPLINGS

WATER MULTICOUPLING MULTICOUPLING SYSTEMS

MULTICOUPLING EQUIVALENTE

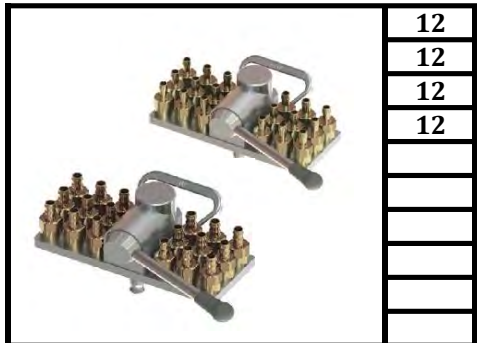

LADO PRENSA - MANGUERA + PUSH LOK

MM 112.18 HGB 12	M 101.09-18 SHB 12
MM 112.18 HGB 16	M 101.09-18 SHB 16
MM 112.18 FGB 13	M 101.09-18 SPB 13
MM 112.18 FGB 16	M 101.09-18 SPB 16

info@hidrafluid.es
Telf: (+34) 976 24 32 10

www.rtc-tec.com
QUICK CONNECT TECHNOLOGY



SERIE M101 RTC



RTC COUPLINGS

**WATER MULTICOUPLING
MULTICOUPLING SYSTEMS**

MULTICOUPLING EQUIVALENTE

LADO PRENSA - ROSCADO

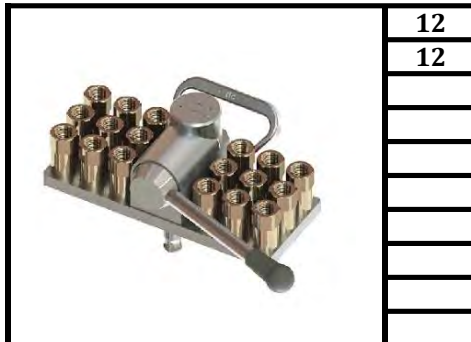

MM 112.18 DGB 17	M 101.12-18 SFB 17
MM 112.18 NGB 17	M 101.12-18 SNB 17

info@hidrafluid.es
Telf: (+34) 976 24 32 10

www.rtc-tec.com
QUICK CONNECT TECHNOLOGY



SERIE M101 RTC



RTC COUPLINGS

WATER MULTICOUPLING
MULTICOUPLING SYSTEMS

MULTICOUPLING EQUIVALENTE

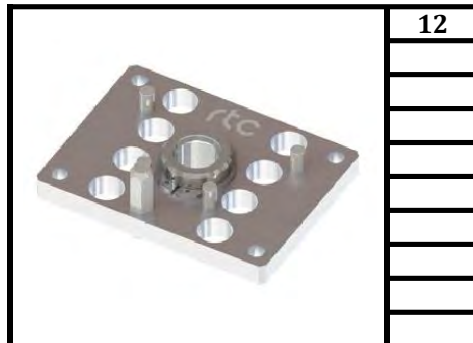

LADO MOLDE

MK 112.18	K 101.12-18

info@hidrafluid.es
Telf: (+34) 976 24 32 10

www.rtc-tec.com
QUICK CONNECT TECHNOLOGY



SERIE M101 RTC



RTC COUPLINGS

WATER MULTICOUPLING MULTICOUPLING SYSTEMS

MULTICOUPLING EQUIVALENTE

6
6
9
9
10
10
12
12

LADO PRENSA - MANGUERA

MM 106.20 HGB 08	M 101.06-20 SHB 08
MM 106.20 HGB 10	M 101.06-20 SHB 10
MM 109.20 HGB 10	M 101.09-20 SHB 10
MM 109.20 HGB 12	M 101.09-20 SHB 12
	M 101.10-20 SHB 10
	M 101.10-20 SHB 12
MM 112.20 HGB 12	M 101.12-20 SHB 12
MM 112.20 HGB 16	M 101.12-20 SHB 16

info@hidrafluid.es

Telf: (+34) 976 24 32 10

www.rtc-tec.com

QUICK CONNECT TECHNOLOGY



SERIE M101 RTC



RTC COUPLINGS

WATER MULTICOUPLING MULTICOUPLING SYSTEMS

MULTICOUPLING EQUIVALENTE

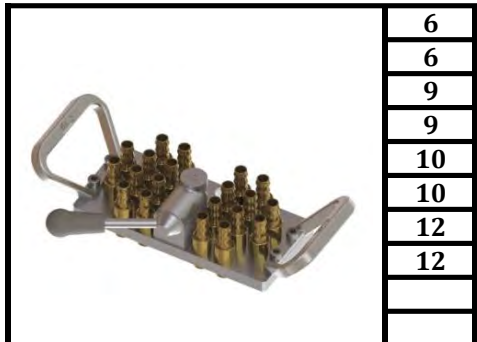

LADO PRENSA - PUSH LOK

MM 106.20 FGB 08	M 101.06-20 SPB 08
MM 106.20 FGB 10	M 101.06-20 SPB 10
MM 109.20 FGB 10	M 101.09-20 SPB 10
MM 109.20 FGB 13	M 101.09-20 SPB 13
	M 101.10-20 SPB 10
	M 101.10-20 SPB 13
MM 112.20 FGB 13	M 101.12-20 SPB 13
MM 112.20 FGB 16	M 101.12-20 SPB 16

info@hidrafluid.es

Telf: (+34) 976 24 32 10

www.rtc-tec.com

QUICK CONNECT TECHNOLOGY



SERIE M101 RTC



RTC COUPLINGS

WATER MULTICOUPLING
MULTICOUPLING SYSTEMS

MULTICOUPLING EQUIVALENTE

	6
	6
	9
	9
	10
	10
	12
	12

LADO PRENSA - ROSCA

MM 106.20 DGB 13	M 101.06-20 SFB 13
MM 106.20 NGB 13	M 101.06-20 SNB 13
MM 109.20 DGB 17	M 101.09-20 SFB 17
MM 109.20 NGB 17	M 101.09-20 SNB 17
	M 101.10-20 SFB 17
	M 101.10-20 SNB 17
MM 112.20 DGB 21	M 101.12-20 SFB 21
MM 112.20 NGB 21	M 101.12-20 SNB 21

info@hidrafluid.es

Telf: (+34) 976 24 32 10

www.rtc-tec.com

QUICK CONNECT TECHNOLOGY



SERIE M101 RTC



RTC COUPLINGS

WATER MULTICOUPLING
MULTICOUPLING SYSTEMS

MULTICOUPLING EQUIVALENTE

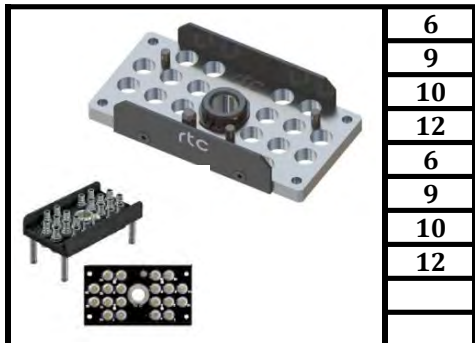

LADO MOLDE

MK 106.20	K 101.06-20
MK 109.20	K 101.09-20
	K 101.10-20
MK 112.20	K 101.12-20
	K 101.06-20 PMB 13
	K 101.09-20 PMB 17
	K 101.10-20 PMB 17
	K 101.12-20 PMB 21

info@hidrafluid.es

Telf: (+34) 976 24 32 10

www.rtc-tec.com

QUICK CONNECT TECHNOLOGY



SERIE M101 RTC



RTC COUPLINGS

WATER MULTICOUPLING MULTICOUPLING SYSTEMS

MULTICOUPLING EQUIVALENTE

	9
	9
	10
	10
	9
	9
	10
	10

LADO PRENSA - MANGUERA + PUSH LOK

MM 109.24 HGB 10	M 101.09-24 SHB 10
MM 109.24 HGB 12	M 101.09-24 SHB 12
	M 101.10-24 SHB 10
	M 101.10-24 SHB 12
MM 109.24 FGB 10	M 101.09-24 SPB 10
MM 109.24 FGB 13	M 101.09-24 SPB 13
	M 101.10-24 SPB 10
	M 101.10-24 SPB 13

info@hidrafluid.es

Telf: (+34) 976 24 32 10

www.rtc-tec.com

QUICK CONNECT TECHNOLOGY



SERIE M101 RTC



RTC COUPLINGS

WATER MULTICOUPLING MULTICOUPLING SYSTEMS

MULTICOUPLING EQUIVALENTE

	9
	9
	10
	10

LADO PRENSA - ROSCADO

MM 109.24 DGB 17	M 101.09-24 SFB 17
MM 109.24 NGB 17	M 101.09-24 SNB 17
	M 101.10-24 SFB 17
	M 101.10-24 SNB 17

info@hidrafluid.es
 Telf: (+34) 976 24 32 10

www.rtc-tec.com
 QUICK CONNECT TECHNOLOGY



SERIE M101 RTC



RTC COUPLINGS

**WATER MULTICOUPLING
MULTICOUPLING SYSTEMS**

MULTICOUPLING EQUIVALENTE

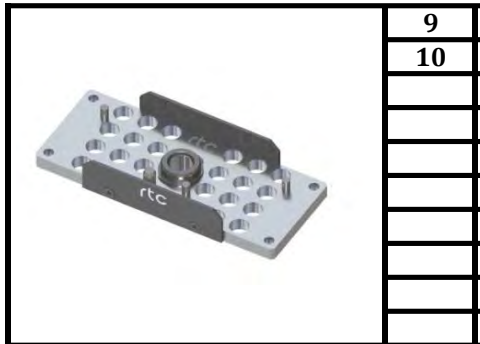

LADO MOLDE

MK 109.24	K 101.09-24
	K 101.10-24

info@hidrafluid.es
Telf: (+34) 976 24 32 10

www.rtc-tec.com
QUICK CONNECT TECHNOLOGY



SERIE M101 RTC



RTC COUPLINGS

WATER MULTICOUPLING MULTICOUPLING SYSTEMS

MULTICOUPLING EQUIVALENTE

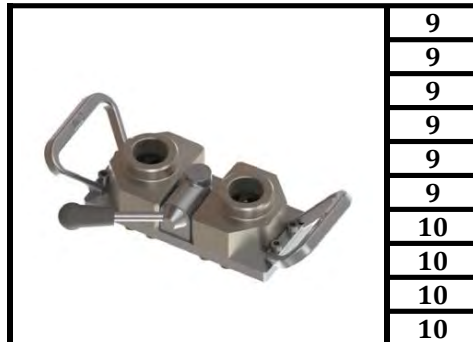

LADO MOLDE

MM 109.12C	M 101.09-12 C 33
MM 109.12CN	M 101.09-12 CN 33
MM 109.20C	M 101.09-20 C 42
MM 109.20CN	M 101.09-20 CN 42
MM 109.24C	M 101.09-24 C 42
MM 109.24CN	M 101.09-24 CN 42
	M 101.10-12 C 33
	M 101.10-12 CN 33
	M 101.10-20 C 42
	M 101.10-20 CN 42

info@hidrafluid.es

Telf: (+34) 976 24 32 10

www.rtc-tec.com

QUICK CONNECT TECHNOLOGY



SERIE M101 RTC



RTC COUPLINGS

WATER MULTICOUPLING MULTICOUPLING SYSTEMS

MULTICOUPLING EQUIVALENTE

	6
	6
	9
	9
	10
	10
	12
	12
	16
	16

ADAPTADORES

MM 106 HGB 08	M 101.06 SHB 08
MM 106 HGB 10	M 101.06 SHB 10
MM 109 HGB 10	M 101.09 SHB 10
MM 109 HGB 12	M 101.09 SHB 12
	M 101.10 SHB 10
	M 101.10 SHB 12
MM 112 HGB 12	M 101.12 SHB 12
MM 112 HGB 16	M 101.12 SHB 16
MM 116 HGB 16	M 101.16 SHB 16
MM 116 HGB 19	M 101.16 SHB 19

info@hidrafluid.es

Tel: (+34) 976 24 32 10

www.rtc-tec.com

QUICK CONNECT TECHNOLOGY



SERIE M101 RTC



RTC COUPLINGS

WATER MULTICOUPLING MULTICOUPLING SYSTEMS

MULTICOUPLING EQUIVALENTE

	6
	6
	9
	9
	10
	10
	12
	12
	16
	16

ADAPTADORES

MM 106 FGB 08	M 101.06 SPB 08
MM 106 FGB 10	M 101.06 SPB 10
MM 109 FGB 10	M 101.09 SPB 10
MM 109 FGB 13	M 101.09 SPB 13
	M 101.10 SPB 10
	M 101.10 SPB 13
MM 112 FGB 13	M 101.12 SPB 13
MM 112 FGB 16	M 101.12 SPB 16
MM 116 FGB 16	M 101.16 SPB 16
MM 116 FGB 19	M 101.16 SPB 19

info@hidrafluid.es

Telf: (+34) 976 24 32 10

www.rtc-tec.com

QUICK CONNECT TECHNOLOGY



SERIE M101 RTC



RTC COUPLINGS

WATER MULTICOUPLING MULTICOUPLING SYSTEMS

MULTICOUPLING EQUIVALENTE

	6
	6
	9
	9
	10
	10
	12
	12
	16
	16

ADAPTADORES

MM 106 DGB 13	M 101.06 SFB 13
MM 106 NGB 13	M 101.06 SNB 13
MM 109 DGB 17	M 101.09 SFB 17
MM 109 NGB 17	M 101.09 SNB 17
	M 101.10 SFB 17
	M 101.10 SNB 17
MM 112 DGB 21	M 101.12 SFB 21
MM 112 NGB 21	M 101.12 SNB 21
MM 116 DGB 26	M 101.16 SFB 26
MM 116 NGB 26	M 101.16 SNB 26

info@hidrafluid.es

Telf: (+34) 976 24 32 10

www.rtc-tec.com

QUICK CONNECT TECHNOLOGY



SERIE M101 RTC



RTC COUPLINGS

WATER MULTICOUPLING
MULTICOUPLING SYSTEMS

MULTICOUPLING EQUIVALENTE

	6
	6
	9
	9
	10
	10
	12
	12
	16
	16

ADAPTADORES

MK 106 DU 13	M 101.06 PFB 13
MK 106 NU 13	M 101.06 PNB 13
MK 109 DU 17	M 101.09 PFB 17
MK 109 NU 17	M 101.09 PNB 17
	M 101.10 PFB 17
	M 101.10 PNB 17
MK 112 DU 21	M 101.12 PFB 21
MK 112 NU 21	M 101.12 PNB 21
MK 116 DU 26	M 101.16 PFB 26
MK 116 NU 26	M 101.16 PNB 26

info@hidrafluid.es

Tel: (+34) 976 24 32 10

www.rtc-tec.com

QUICK CONNECT TECHNOLOGY



SERIE M101 RTC



RTC COUPLINGS

WATER MULTICOUPLING MULTICOUPLING SYSTEMS

MULTICOUPLING EQUIVALENTE

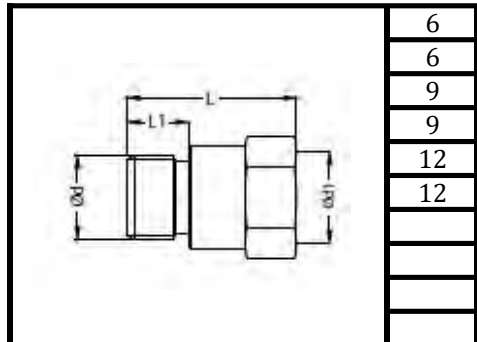

ADAPTADORES

106 EN 13	TE 13-13 - 14
106 NN 13	TEN 13-13 - 14
109 EN 17	TE 17-17 - 20
109 NN 17	TEN 17-17 - 20
112 EN 21	TE 21-21 - 24
112 NN 21	TEN 21-21 - 24

info@hidrafluid.es
Telf: (+34) 976 24 32 10

www.rtc-tec.com
QUICK CONNECT TECHNOLOGY