



Blades for plastic – Series SF-20



Product notes

- > Forged blades from high alloy steel and heat surface treated
- > Suitable for all nippers of the size 20

Technical data

Item no.	Plug design	Max. opening width [mm]	Max. sprue diameter [mm]	Material	Weight [g]	Air nippers
SF20.A40.51	40° angle	17	9	Ferrous alloy	170	GT-N20, GT-NR20, GT-NS20

Dimensions

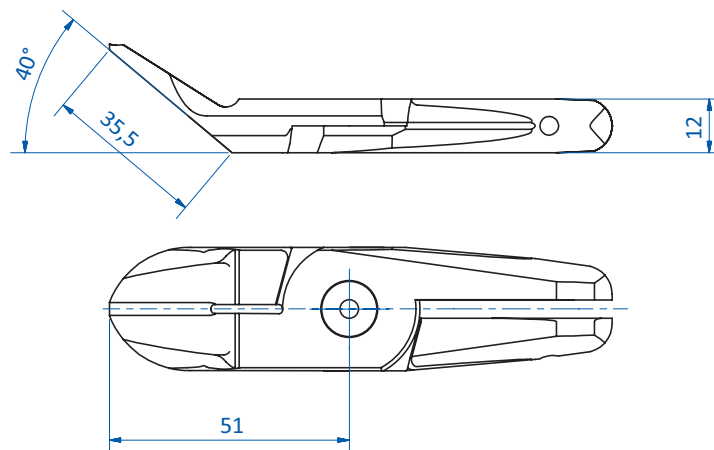

SF20.A40.51